

CMSH1-20 CMSH1-60
 CMSH1-40 CMSH1-100

**SURFACE MOUNT SILICON
 SCHOTTKY RECTIFIERS
 1.0 AMP, 20 THRU 100 VOLT**



SMB CASE



www.centralemi.com

DESCRIPTION:

The CENTRAL SEMICONDUCTOR CMSH1-20 series 1.0 Amp surface mount silicon rectifier is a high quality, well constructed, highly reliable component designed for use in all types of commercial, industrial, entertainment, computer, and automotive applications.

MARKING CODE: SEE MARKING CODE TABLE ON FOLLOWING PAGE

FEATURES:

- High reliability
- Special selections available

MAXIMUM RATINGS: ($T_A=25^\circ\text{C}$ unless otherwise noted)

	SYMBOL	CMSH1 -20	CMSH1 -40	CMSH1 -60	CMSH1 -100	UNITS
Peak Repetitive Reverse Voltage	V_{RRM}	20	40	60	100	V
DC Blocking Voltage	V_R	20	40	60	100	V
RMS Reverse Voltage	$V_{R(RMS)}$	14	28	42	70	V
Average Forward Current ($T_A=75^\circ\text{C}$)	I_O			1.0		A
Peak Forward Surge Current, $t_p=8.3\text{ms}$	I_{FSM}			30		A
Operating and Storage Junction Temperature	T_J, T_{stg}			-65 to +150		$^\circ\text{C}$
Thermal Resistance	θ_{JL}			20		$^\circ\text{C/W}$

ELECTRICAL CHARACTERISTICS: ($T_A=25^\circ\text{C}$ unless otherwise noted)

SYMBOL	TEST CONDITIONS	TYP	MAX	UNITS
I_R	$V_R=\text{Rated } V_{RRM}$		0.50	mA
I_R	$V_R=\text{Rated } V_{RRM}, T_A=125^\circ\text{C}$		20	mA
V_F	$I_F=1.0\text{A}$ (CMSH1-20)	0.46	0.55	V
V_F	$I_F=1.0\text{A}$ (CMSH1-40)	0.48	0.55	V
V_F	$I_F=1.0\text{A}$ (CMSH1-60)	0.48	0.70	V
V_F	$I_F=1.0\text{A}$ (CMSH1-100)	0.75	0.85	V
C_J	$V_R=4.0\text{V}, f=1.0\text{MHz}$, (CMSH1-20)	68		pF
C_J	$V_R=4.0\text{V}, f=1.0\text{MHz}$, (CMSH1-40)	56		pF
C_J	$V_R=4.0\text{V}, f=1.0\text{MHz}$, (CMSH1-60)	42		pF
C_J	$V_R=4.0\text{V}, f=1.0\text{MHz}$, (CMSH1-100)	45		pF

CMSH1-20 CMSH1-60
 CMSH1-40 CMSH1-100

**SURFACE MOUNT SILICON
 SCHOTTKY RECTIFIERS
 1.0 AMP, 20 THRU 100 VOLT**



SMB CASE - MECHANICAL OUTLINE

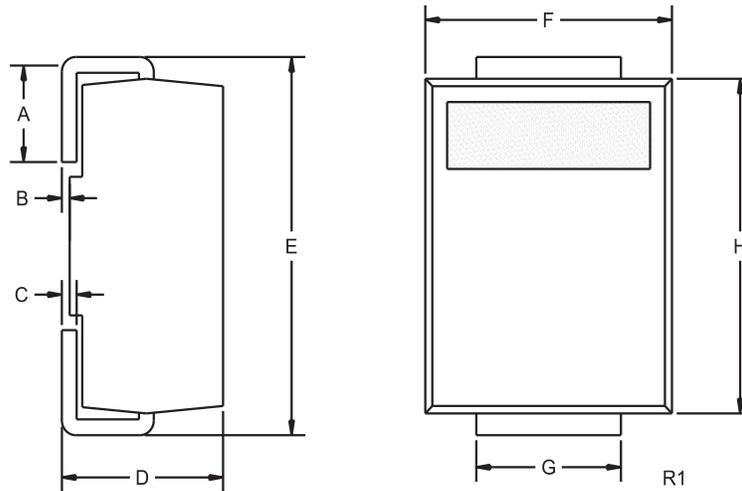

DEVICE	MARKING CODE
CMSH1-20	CS20
CMSH1-40	CS40
CMSH1-60	CS60
CMSH1-100	CS100

SYMBOL	DIMENSIONS			
	INCHES		MILLIMETERS	
	MIN	MAX	MIN	MAX
A	0.030	0.060	0.76	1.52
B	0.004	0.008	0.10	0.20
C	0.006	0.012	0.15	0.30
D	0.086	0.096	2.18	2.44
E	0.200	0.220	5.08	5.59
F	0.130	0.150	3.30	3.81
G	0.077	0.083	1.96	2.11
H	0.160	0.180	4.06	4.57

SMB (REV: R1)

R4 (7-December 2015)

CMSH1-20 CMSH1-60
 CMSH1-40 CMSH1-100

SURFACE MOUNT SILICON
 SCHOTTKY RECTIFIERS
 1.0 AMP, 20 THRU 100 VOLT



TYPICAL ELECTRICAL CHARACTERISTICS

Leakage Current for CMSH1-20

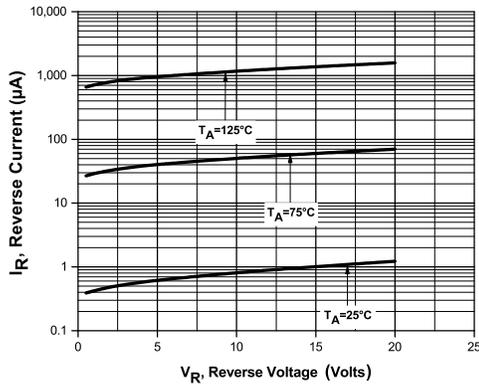

Leakage Current for CMSH1-40

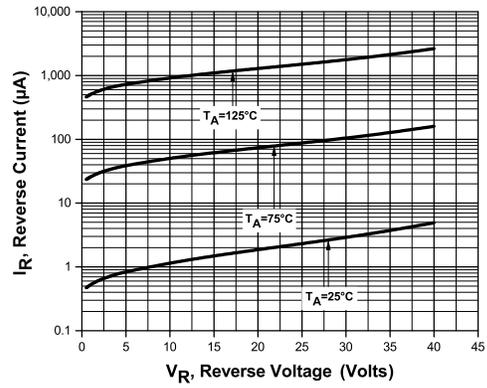

Leakage Current for CMSH1-60

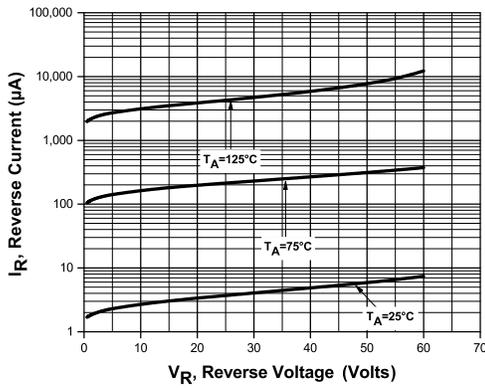

Leakage Current for CMSH1-100

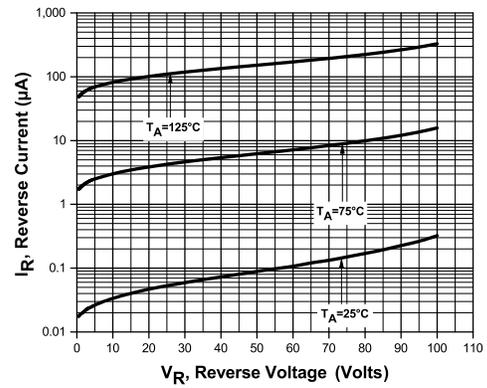

R4 (7-December 2015)

CMSH1-20 CMSH1-60
 CMSH1-40 CMSH1-100

**SURFACE MOUNT SILICON
 SCHOTTKY RECTIFIERS
 1.0 AMP, 20 THRU 100 VOLT**



TYPICAL ELECTRICAL CHARACTERISTICS

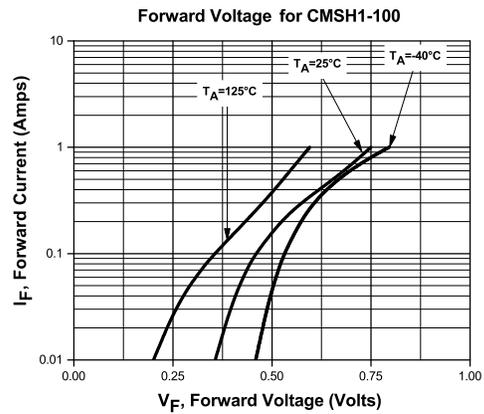
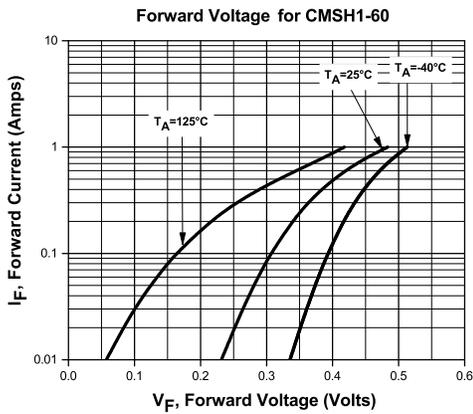
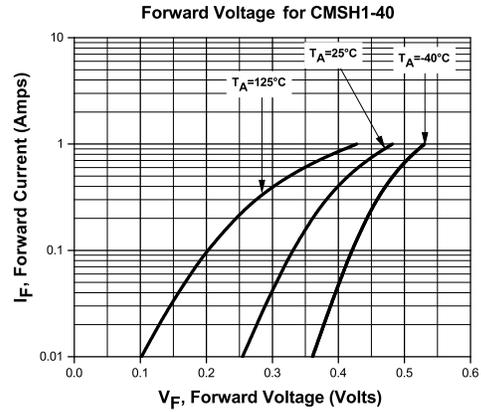
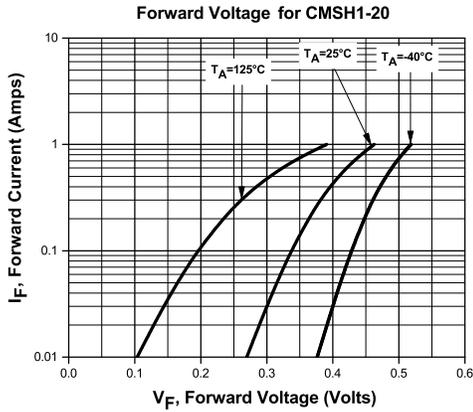

R4 (7-December 2015)

CMSH1-20 CMSH1-60
CMSH1-40 CMSH1-100

**SURFACE MOUNT SILICON
SCHOTTKY RECTIFIERS
1.0 AMP, 20 THRU 100 VOLT**



TYPICAL ELECTRICAL CHARACTERISTICS

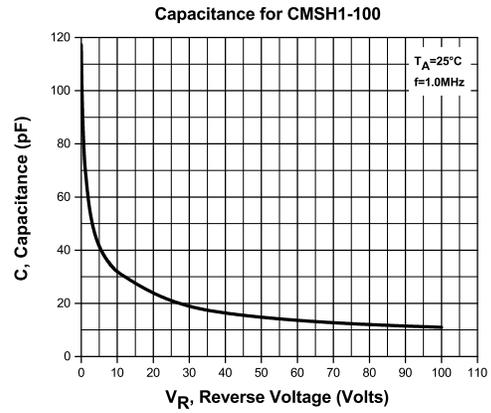
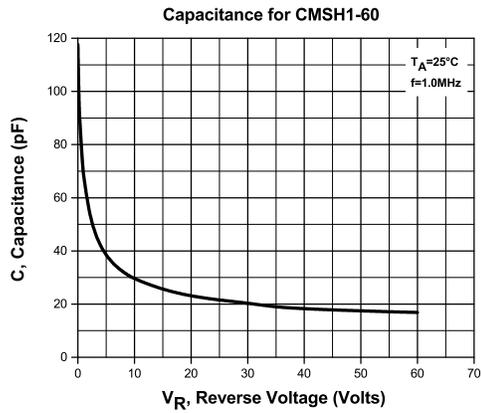
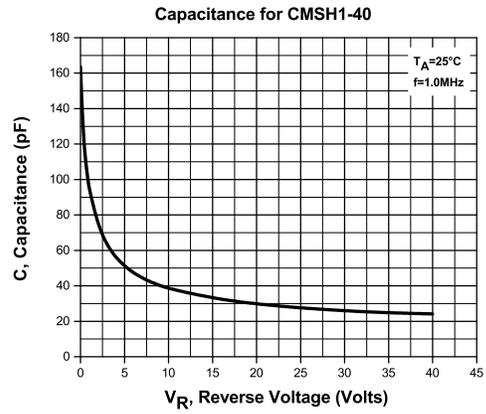
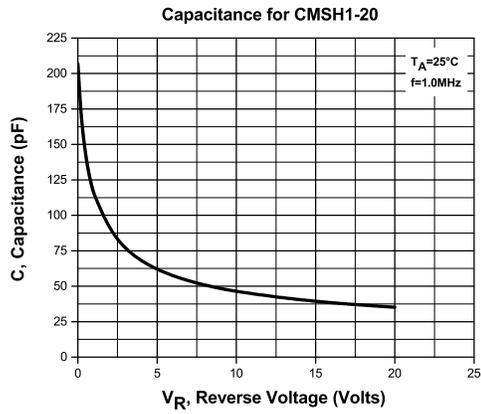

R4 (7-December 2015)

CMSH1-20 CMSH1-60
CMSH1-40 CMSH1-100

SURFACE MOUNT SILICON
SCHOTTKY RECTIFIERS
1.0 AMP, 20 THRU 100 VOLT



TYPICAL ELECTRICAL CHARACTERISTICS

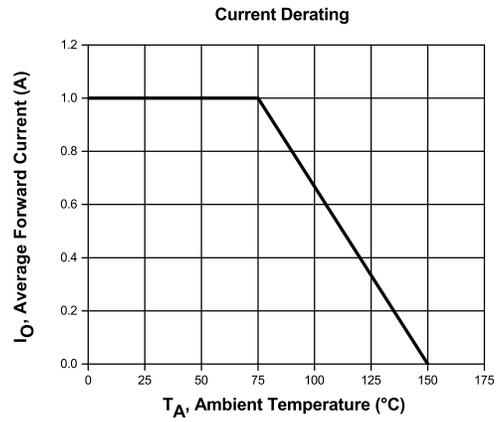

R4 (7-December 2015)

OUTSTANDING SUPPORT AND SUPERIOR SERVICES



PRODUCT SUPPORT

Central's operations team provides the highest level of support to insure product is delivered on-time.

- Supply management (Customer portals)
- Inventory bonding
- Consolidated shipping options
- Custom bar coding for shipments
- Custom product packing

DESIGNER SUPPORT/SERVICES

Central's applications engineering team is ready to discuss your design challenges. Just ask.

- Free quick ship samples (2nd day air)
- Online technical data and parametric search
- SPICE models
- Custom electrical curves
- Environmental regulation compliance
- Customer specific screening
- Up-screening capabilities
- Special wafer diffusions
- PbSn plating options
- Package details
- Application notes
- Application and design sample kits
- Custom product and package development

CONTACT US

Corporate Headquarters & Customer Support Team

Central Semiconductor Corp.
145 Adams Avenue
Hauppauge, NY 11788 USA
Main Tel: (631) 435-1110
Main Fax: (631) 435-1824
Support Team Fax: (631) 435-3388
www.centalsemi.com

Worldwide Field Representatives:
www.centalsemi.com/wwreps

Worldwide Distributors:
www.centalsemi.com/wwdistributors

For the latest version of Central Semiconductor's **LIMITATIONS AND DAMAGES DISCLAIMER**, which is part of Central's Standard Terms and Conditions of sale, visit: www.centalsemi.com/terms